

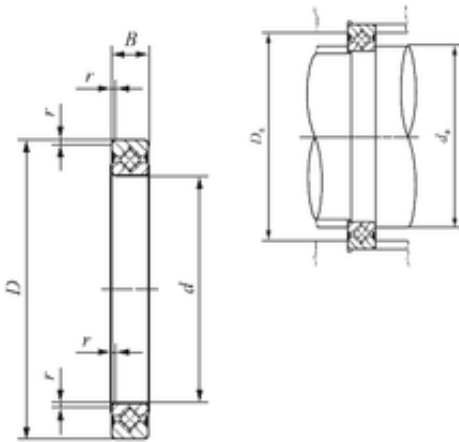

## NTN Driveshaft CORP.

### 50 mm x 66 mm x 8 mm IKO CRBS 508 A UU thrust roller bearings

Bearing No. CRBS 508 A UU



CRBS 508 A UU Bearing 2D drawings and 3D CAD models

Size	50x66x8 mm
Bore Diameter	50 mm
Outer Diameter	66 mm
Width	8 mm
d	50 mm
D	66 mm
B	8 mm
r min.	0.4 mm
Da	61 mm
da	54 mm
Weight	0,084 Kg
Basic dynamic load rating (C)	4,68 kN